

PetSafe[®]

In-Ground Radio Fence[™]

Operating and Training Guide

Please read this entire guide before beginning

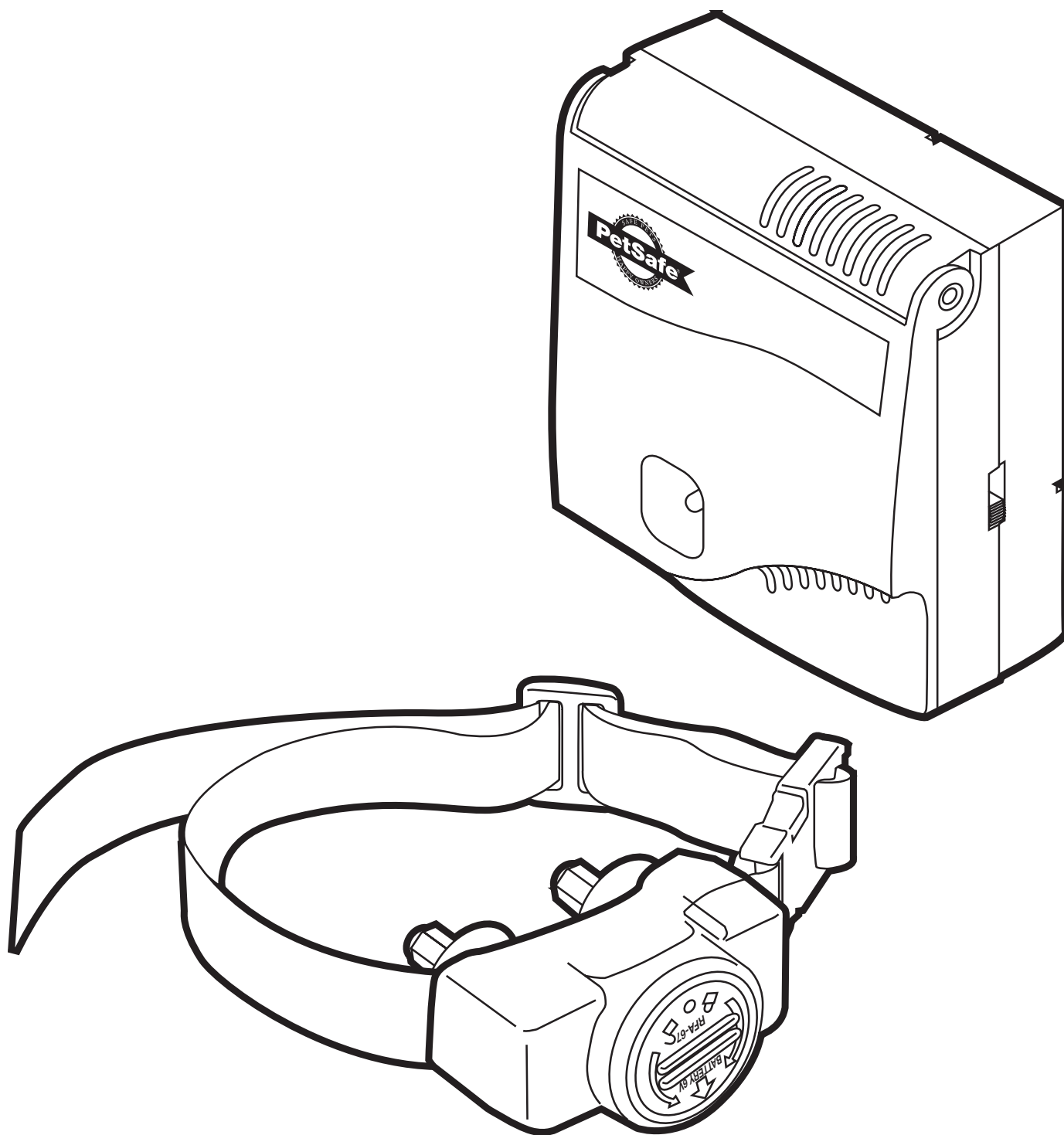

Thank you for choosing PetSafe®, the #1 selling brand of electronic training solutions in the world. Our mission is to ensure your pet's safety by providing you the tools and techniques to successfully train your pet. If you have any questions, please contact the Customer Care Center at 1-800-732-2677 or visit our website at www.petsafe.net.

Table of Contents

Components	3
Other Items You May Need.....	3
How the System Works	4
Key Definitions	4
Operating Guide	
Locate the Fence Transmitter.....	5
Lay Out the System.....	5
Sample Layouts.....	6
Position the Boundary Wire	7
Connect the Wires to the Fence Transmitter	8
Prepare the Receiver Collar.....	8
Set the Boundary Width and Test the Receiver Collar.....	9
Install the Boundary Wire	10
Place the Boundary Flags	11
Fit the Receiver Collar.....	11
Training Guide	
Be Patient With Your Pet	13
Days 1 and 2 - Boundary Flag Awareness	13
Days 3 and 4 - Continue Boundary Flag Awareness	14
Days 5 thru 8 - Distraction Phase	14
Days 9 thru 14 - Unleashed Supervision.....	15
Days 15 thru 30 - Pet Monitoring	15
Taking Your Pet Out of the Pet Area	15
Accessories	16
Troubleshooting.....	16
Short Loop Test	17
To Locate a Break in the Wire	18
Terms of Use and Limitation of Liability	18
FCC	19
Caution	19
Layout Grid	20
Mounting Template	20

Components

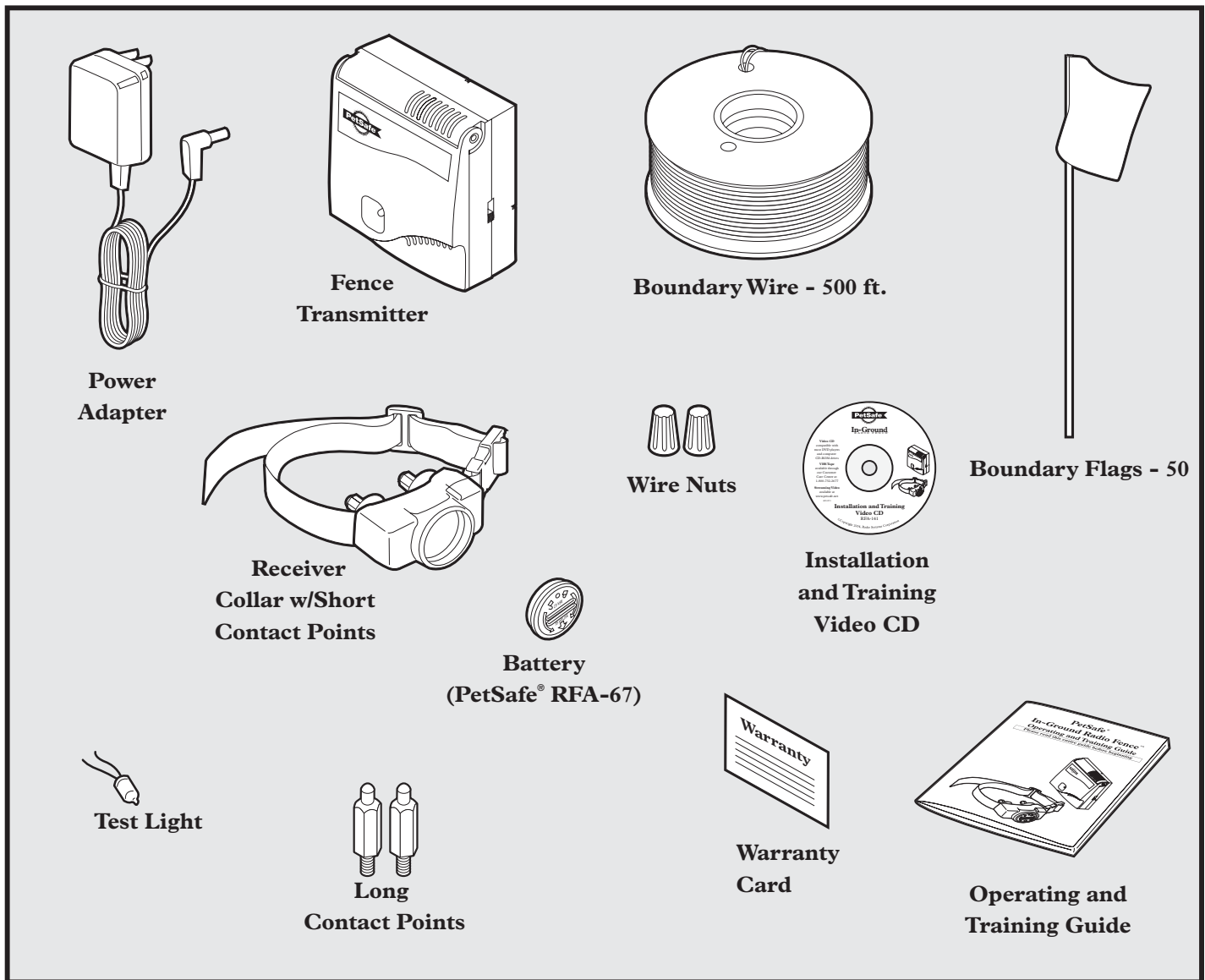

Other Items You May Need

- Additional wire and flags (Part #PRFA-500)
- Tape measure
- Small Phillips screwdriver
- Drill & mounting hardware
- Shovel or lawn edger
- Pliers
- Wire stripping pliers
- Scissors
- Lighter
- Electrical tape
- Additional wire nuts
- Waterproofing compound (e.g. silicone caulk)
- PVC pipe or water hose
- Circular saw with masonry blade
- Patching compound
- Staple gun
- Non-metallic collar and leash

Note: For information on professional installation of your new PetSafe In-Ground Radio Fence™, contact the Customer Care Center at 1-800-732-2677 or visit our website at www.petsafeprofessional.com.

How the System Works

The PetSafe In-Ground Radio Fence™ has been proven safe, comfortable, and effective for all pets over 8 pounds. The system works by producing a radio signal from the Fence Transmitter through up to 2800 feet of Boundary Wire. The Boundary Wire is buried or attached to a fixed object to enclose the Pet Area. You temporarily define this Pet Area with Boundary Flags for a visual aid in training your pet. Your pet wears a Receiver Collar with Contact Points that touch his neck, and, once trained, is allowed to roam freely in the Pet Area. When your pet reaches the Warning Zone, the Receiver Collar gives a warning beep. If your pet continues into the Static Correction Zone, a safe Static Correction will be delivered through the Contact Points to get his attention until he returns to the Pet Area.

Key Definitions

Fence Transmitter: The device that transmits the radio signal through the Boundary Wire.

Pet Area: The area within the Warning Zone where your pet can roam freely.

Warning Zone: The outer edge of the Pet Area where your pet's Receiver Collar begins to beep, warning him not to go into the Static Correction Zone.

Static Correction Zone: The zone beyond the Warning Zone where your pet's Receiver Collar will emit a Static Correction, signaling him to return to the Pet Area.

Boundary Width: The combination of the Warning Zone and the Static Correction Zone.

Receiver Collar: The device that receives the radio signal from the Boundary Wire.

Contact Points: The contacts through which the Receiver Collar delivers the safe Static Correction when your pet moves into the Static Correction Zone.

Power Jack: The jack where the Power Adapter plugs into the Fence Transmitter. The Fence Transmitter is powered by a standard 120-volt outlet.

Boundary Control Switch: The switch to adjust according to the length of Boundary Wire used.

Boundary Wire Terminals: The terminals where the Boundary Wires connect to the Fence Transmitter in order to complete a continuous loop.

Loop Indicator Light: The light that indicates that the Boundary Wire makes a complete loop, enabling the signal to be transmitted.

Boundary Width Control: The knob that adjusts the width of the Warning and Static Correction Zones. *Note: Adjusting the knob does not change the level of Static Correction on the Receiver Collar.*

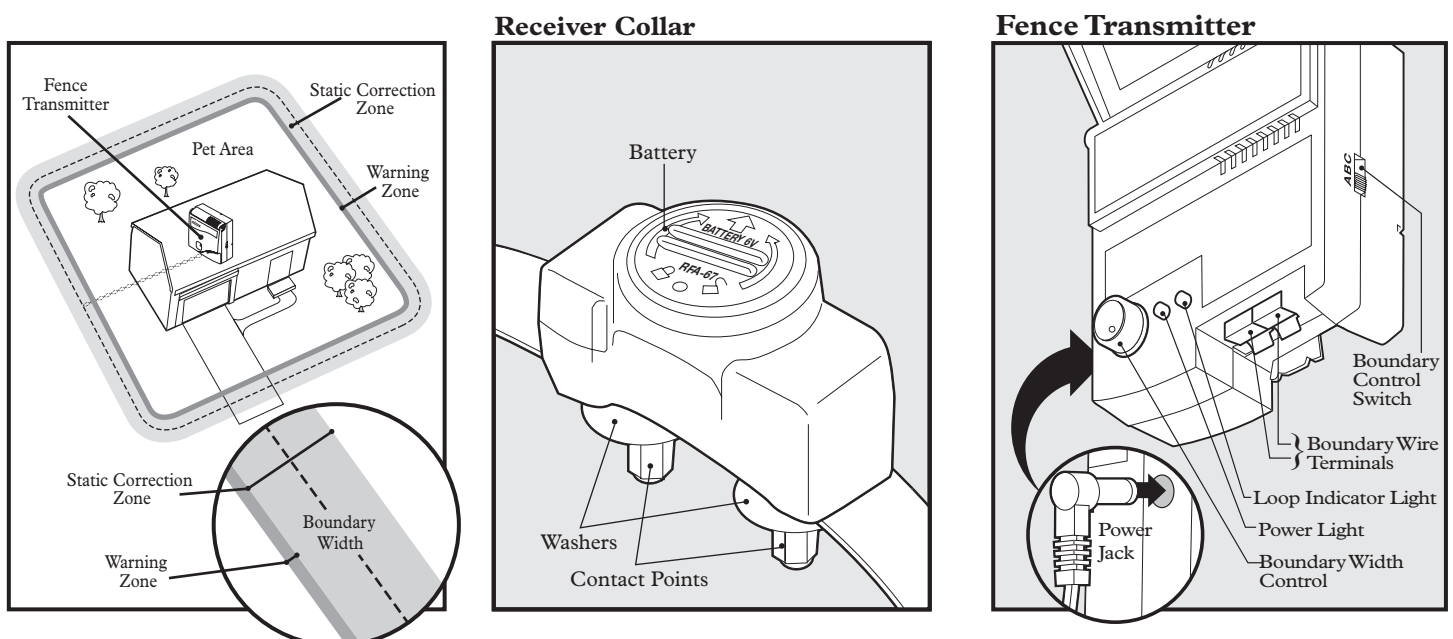

Operating Guide

Step 1 Locate the Fence Transmitter

1

Place the Fence Transmitter:

- In a dry, well ventilated, protected area (**1A, 1B**).
- In an area where temperatures do not fall below freezing (e.g., garage, basement, shed, closet).
- Secured to a stationary surface using appropriate mounting hardware (not included). A mounting template is included in the back of this guide.
- At least 3 feet from large metal objects or appliances as these items may interfere with the signal consistency (**1C**).

Once you have mounted the Fence Transmitter, the Boundary Wire must exit the building. This can be accomplished via a window or through a 1/8" hole drilled through the wall. Ensure the drill path is clear of any utilities. Make sure the Boundary Wire is not cut off or pinched by a window, door, or garage door, as this can damage it over time.

To prevent fires and electrical hazards, install the Fence Transmitter in buildings that are in accordance with state and local electrical codes.

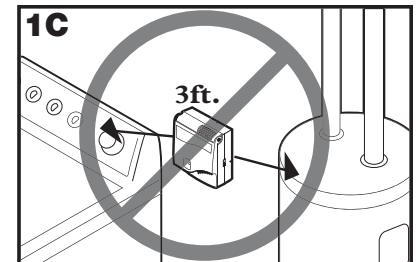
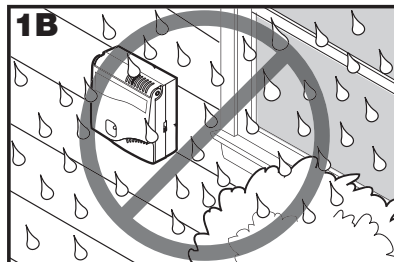
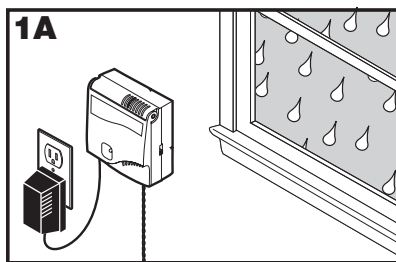

Step 2 Lay Out the System

2

Basic Planning Tips

- The Boundary Wire **MUST** start at the Fence Transmitter and make a continuous loop back (**2A**).
- Design a layout that is suitable for your yard. Sample layouts are provided in this section, and a grid for designing your layout is provided in the back of this guide.
- Always use gradual turns at the corners to produce a more consistent boundary (**2B**). Do not use sharp turns, as this will cause gaps in your boundary.
- Avoid making passageways too narrow for your pet to move about freely (e.g., along the sides of a house).
- The Receiver Collar can be activated inside the house if the Boundary Wire runs along the outside wall of the house. If this occurs, remove your pet's Receiver Collar before bringing him inside, decrease the range using the Boundary Width Control knob or consider an alternative layout.

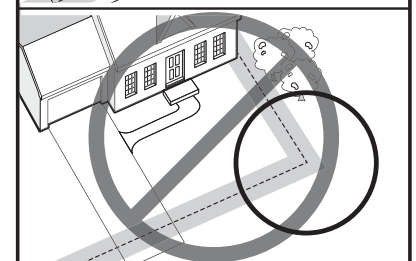
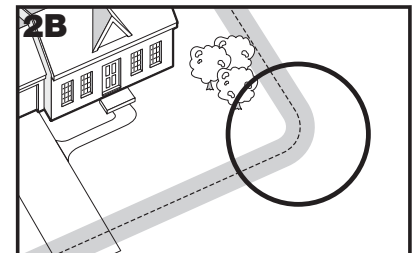
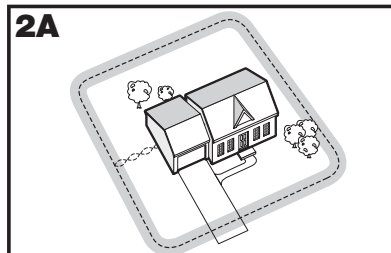

Sample Layouts

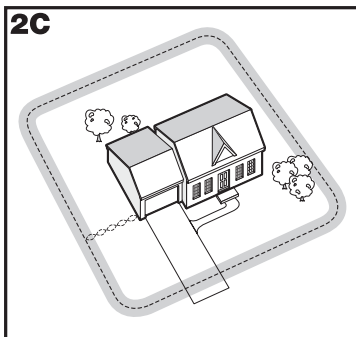

Sample 1: Perimeter Loop (Single Loop)

The Perimeter Loop is the most common layout. This will allow your pet to freely and safely roam your entire property (2C). It can also protect gardens, pools and landscaping (2D).

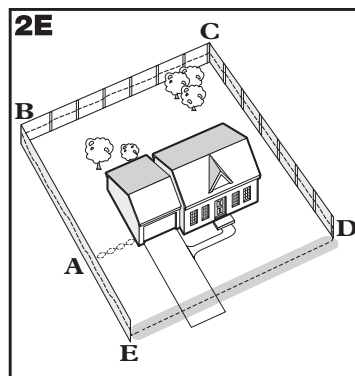
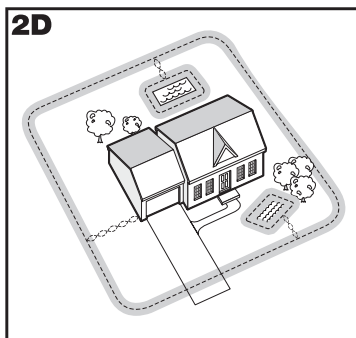

Sample 2 (2E): Perimeter Loop Using Existing Fence (Single Loop)

This layout allows you to include your existing fence as part of your layout and keep your pet from jumping out or digging under your existing fence. It reduces the amount of wire which will need to be buried. From the Fence Transmitter, run the wire to **A**, **A** to **B**, **B** to **C**, **C** to **D**, **D** to **E**, **E** to **A**, twist the wires from **A** back to the Fence Transmitter. See the “Install the Boundary Wire” section for more information on attaching the wire to a fence.

Double Loop

A Double Loop must be used when you are not establishing the Boundary Zone on all sides of your property.

When using a Double Loop, the Boundary Wire must be separated by a minimum of **THREE TO FIVE FEET** to avoid canceling the signal. Remember that a Double Loop will require twice as much wire.

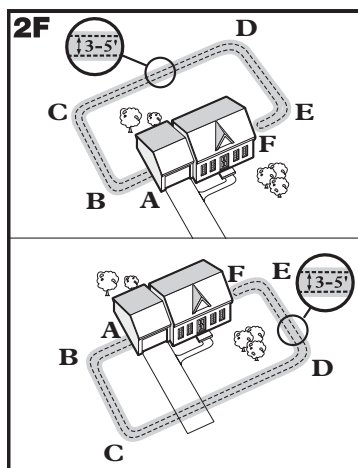

Sample 3 (2F): Front or Back Yard Only (Double Loop)

From the Fence Transmitter, run the wire to **A**, **A** to **B**, **B** to **C**, **C** to **D**, **D** to **E**, **E** to **F**, make a U-turn and follow your path all the way back to **A**, keeping the wire separated **three to five feet**. Twist the wire from **A** back to the Fence Transmitter.

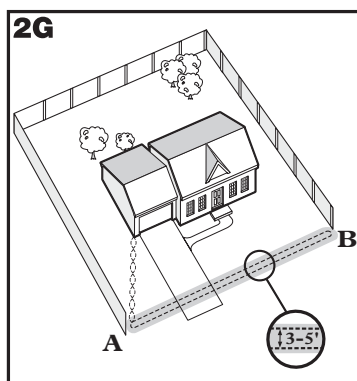

Sample 4 (2G): Front Boundary Only (Double Loop)

From the Fence Transmitter, run the wire to **A**, **A** to **B**, **B** back to **A** keeping the wire separated **three to five feet**. Twist the wire from **A** back to the Fence Transmitter.

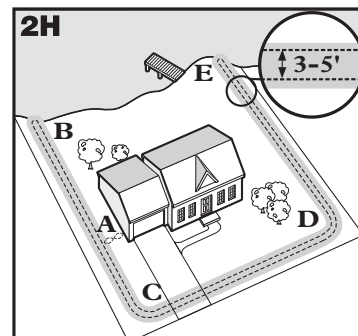

Sample 5 (2H): Lake Access (Double Loop)

From the Fence Transmitter, run the wire to **A**, **A** to **B**, make a U-turn and go to **C**, **C** to **D**, **D** to **E**, make a U-turn and follow your path all the way back to **A** keeping wire separated **three to five feet**. Twist the wire from **A** back to the Fence Transmitter.

Sample 6 (2J): Wire Loop Attached to Existing Fence (Double Loop)

This layout allows you to include your existing fence as part of your layout and keep your pet from jumping out or digging under your existing fence. It reduces the amount of wire which will need to be buried. Run the wire from the Fence Transmitter to **A**, **A** to **B**, **B** to **C**, **C** to **D**, **D** to **E**, **E** to **F**, make a U-turn and follow your path all the way back to **A**, keeping the wire separated **three to five feet**. Twist the wire from **A** back to the Fence Transmitter. See the “Install the Boundary Wire” section for more information on attaching the wire to a fence.

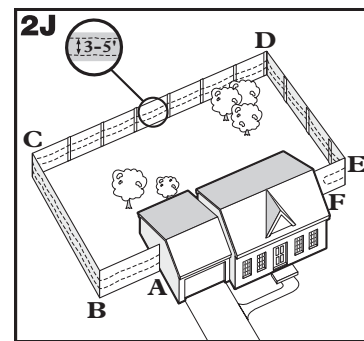

Step 3 Position the Boundary Wire

Lay out the Boundary Wire using your proposed boundary and test the system BEFORE burying the wire or attaching it to an existing fence. This will make any layout changes easier.

Running the Boundary Wire parallel to and within five feet of electrical wires, neighboring containment systems, telephone wires, television or antenna cables, or satellite dishes will cause an inconsistent signal. If you must cross any of these, do so at 90-degree angles (perpendicularly).

If separating the wire by at least five feet from a neighboring containment system's wire does not reduce the inconsistent signal, contact the Customer Care Center at 1-800-732-2677.

To Twist the Boundary Wire (3A)

Twisting the Boundary Wire cancels the signal and allows your pet to cross over that area safely. Plastic or metal piping will not cancel the signal. Twist the Boundary Wire 8 to 10 times per foot to cancel the signal.

To Splice or Repair the Boundary Wire (3B)

If you need additional Boundary Wire to expand your wire loop, you will need to splice the wires together. Note the locations of all splices for future reference. Most Boundary Wire breaks occur at splices.

Strip approximately one-half inch of insulation off the ends of the Boundary Wires to be spliced. Make sure the copper Boundary Wire is not corroded. If the Boundary Wire is corroded, cut it back to expose clean copper wire.

Insert the stripped ends into the wire nut and twist the wire nut around the wires. Pull on the wires to make sure you have a strong splice connection. Apply waterproofing compound (e.g. silicone caulk) in and around the wire nut or wrap the wires and the wire nuts with electrical tape to prevent moisture from corroding the copper.

If your splice pulls loose, the entire system will fail. Make sure your splice is secure.

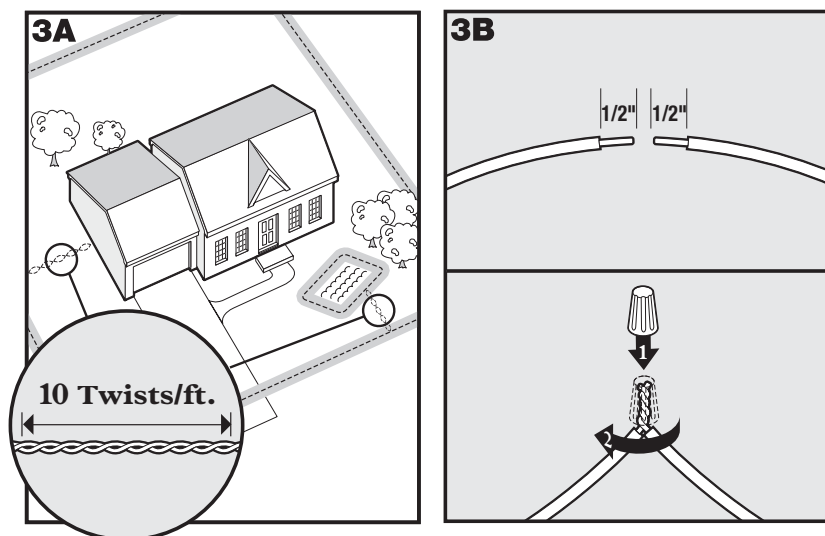

Additional Boundary Wire

We recommend the use of 20 gauge insulated multi-strand copper wire for direct burial. Extra Boundary Wire can be purchased in 500 foot spools at the store where you purchased the kit or through the Customer Care Center at 1-800-732-2677.

Note: When adding Boundary Wire, it must act as a continuous loop.

The table at right indicates the approximate length of Boundary Wire needed for a rectangular, Single Loop layout. Length will vary due to the amount of twisted wire and layout used.

Acres	Feet of Wire Needed
1/4	415
1/3	480
1/2	590
1	835
2	1180
5	1870
10	2800

Step 4 Connect the Wires to the Fence Transmitter

Boundary Wire (4A)

1. Run the Boundary Wire to the Fence Transmitter through a window, under a door, through a crawl space vent, or any other appropriate available access. You can also drill a hole through your wall.
2. Strip the ends of the Boundary Wire approximately one-half inch.
3. Insert the Boundary Wires into the Boundary Wire Terminals on the Fence Transmitter.
4. Turn the Boundary Width Control knob to 10. This will set the Warning Zone at the maximum width.
5. Plug the Power Adapter into the Power Jack and a 120-volt outlet.
6. The Power Light and Loop Indicator Lights should come on. If this does not happen, see the "Troubleshooting" section.

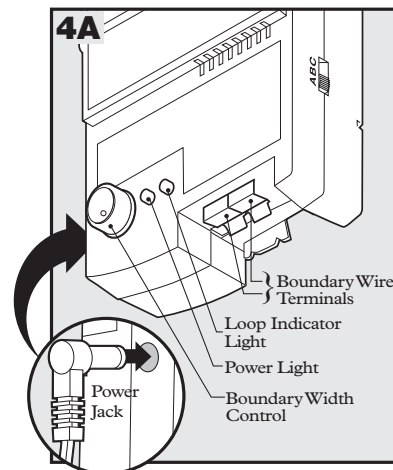

Lightning Protection

You may purchase a Lightning Protection Kit through the Customer Care Center at 1-800-732-2677. The Lightning Protection Kit protects the system against surges that travel through the power source and/or the Boundary Wire.

Step 5 Prepare the Receiver Collar

Your Receiver Collar comes with short Contact Points installed. Use the long Contact Points for pets with long or thick hair. Tighten the Contact Points with pliers one-half turn beyond finger tight (5A). Check the tightness weekly.

To Insert and Remove the Battery

Note: Do not install the battery while the Receiver Collar is on your pet.

This Receiver Collar utilizes a replaceable PetSafe® battery (RFA-67). This unique battery is designed to make battery replacement easier and increase water protection.

To insert the battery, align the symbols on the battery (arrow) and Receiver Collar (triangle) (5B). Use a large coin to turn the battery clockwise until the arrow lines up with the lock symbol on the housing (5C).

To remove the battery, turn the battery counter-clockwise using a large coin (5D, 5E). DO NOT attempt to cut into or pry open the battery. Be sure to discard the used battery properly.

A replacement PetSafe® battery (RFA-67) can be found at many retailers. Contact the Customer Care Center at 1-800-732-2677 or visit our web site at www.petsafe.net to locate a retailer near you.

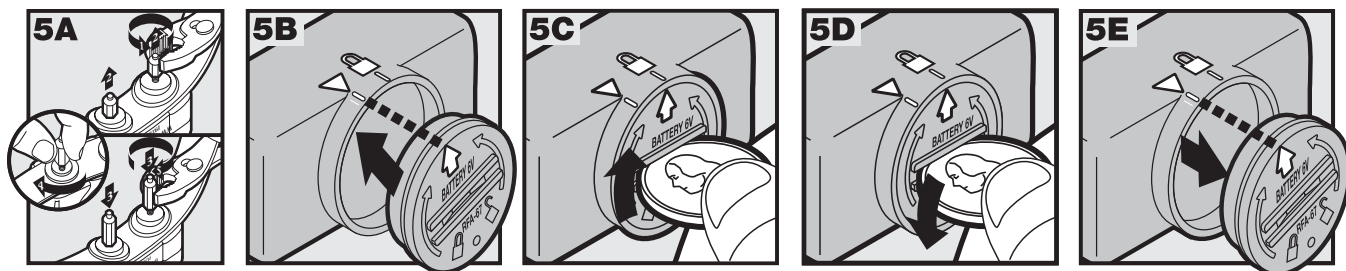

Step 6 Set the Boundary Width and Test the Receiver Collar

The Boundary Control Switch on the side of the Fence Transmitter has three settings (6A). Setting B is used for most properties. The following table will indicate the setting you should use.

Amount of Wire	Setting
Up to 1300 feet	B
1300-2400	C
Greater than 2400 feet	A

Use the Boundary Width Control knob to set the width of the Warning Zone and Static Correction Zone (6B). Set the Boundary Width as wide as possible to give your pet the widest Warning and Static Correction Zones without reducing the Pet Area too much.

Note: The Boundary Width Control knob does not change the Static Correction Level.

To identify the Warning and Static Correction Zones, make sure the Receiver Collar battery is properly installed and the Test Light is attached to the Contact Points (6C, 6D). Walk toward the Boundary Wire with Contact Points pointing up and holding the Receiver Collar at your pet's neck level (6E) until the Receiver Collar beeps (6F).

Note: The Receiver Collar is waterproof, which can make the beep hard to hear.

If the Receiver Collar does not beep at the desired range, adjust the Boundary Width Control knob to the desired setting. Turning the Boundary Width Control knob clockwise increases the Boundary Width while turning it counterclockwise decreases it (6B). Repeat this activity as needed until the Receiver Collar beeps at the desired distance from the Boundary Wire.

The numbers on the Boundary Width Control knob indicate signal strength and are not representative of Boundary Width footage. If adjusting the Boundary Width Control knob does not give the desired range, adjust the Boundary Control Switch to another setting to achieve your desired range. If using a Double Loop, you may need to increase the separation of the Boundary Wire to achieve desired range.

The Receiver Collar beeps as a warning tone and ticks when delivering a Static Correction. After hearing the beep, continue to walk towards the wire. The Receiver Collar should tick and the Test Light should flash, indicating the Static Correction as you enter the Static Correction Zone (6G). A warning tone and the flashing of the Test Light indicate that the Receiver Collar and the system are working properly and that you are ready to start burying the Boundary Wire. If the Receiver Collar did not beep or the Test Light did not flash, see the "Troubleshooting" section.

Important: Remove the Test Light before placing the Receiver Collar on your pet.

Note: The Boundary Width is broken down into 20% Warning Zone and 80% Static Correction Zone.

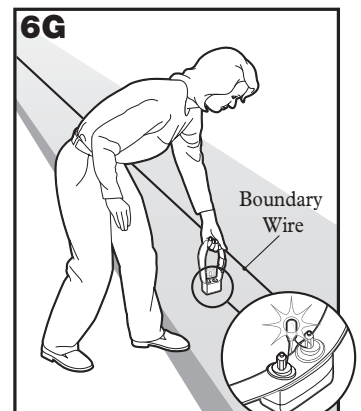
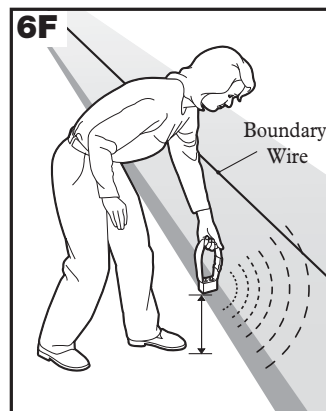
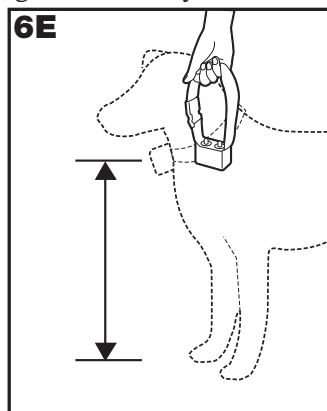
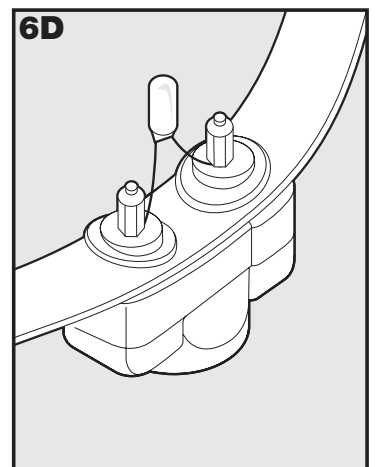
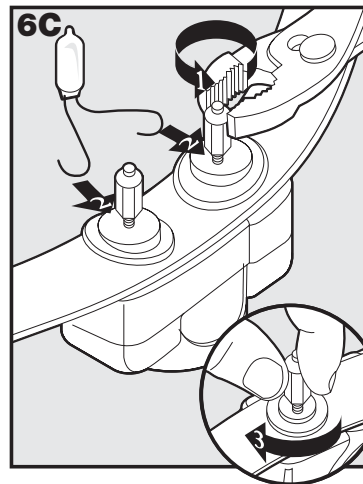
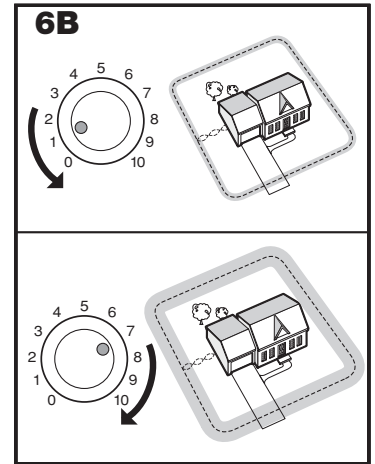
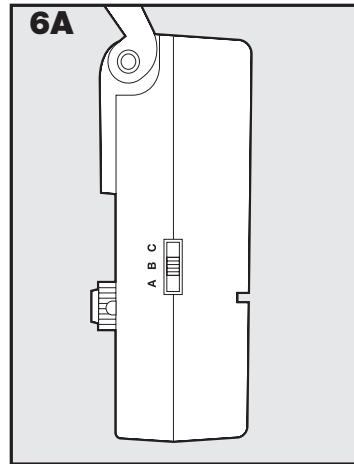

Step 7 Install the Boundary Wire

To Bury the Boundary Wire

Burying the Boundary Wire is recommended to protect it and prevent disabling the system.

1. Cut a trench **1-3 inches** deep along your planned boundary.
2. Place the Boundary Wire into the trench maintaining some slack to allow it to expand and contract with temperature variations.
3. Use a blunt tool such as a wooden paint stick to push the Boundary Wire into the trench. Be careful not to damage the Boundary Wire.

To Attach the Boundary Wire to an Existing Fence

The Boundary Wire of the PetSafe In-Ground Radio Fence™ can be attached to a chain link fence, split rail fence, or a wooden privacy fence. The Boundary Wire can be attached as high as needed. However, make sure the Boundary Width is set at a high enough range for the pet to receive the signal. If using a Double Loop with an existing fence at least three feet tall, run the Boundary Wire on top of the fence and return it on the bottom of the fence to get the three to five foot separation needed.

- **Chain Link Fence (7A):** Weave Boundary Wire through the links or use plastic quick ties.
- **Wooden Split Rail or Privacy Fence (7A):** Use staples to attach Boundary Wire. Avoid puncturing the insulation of the Boundary Wire.
- **Double Loop with an Existing Fence:** Run the Boundary Wire on top of the fence and return it on the bottom of the fence to get the three to five foot separation needed.
- **Gate (Single Loop) (7B) :** Bury the Boundary Wire in the ground across the gate opening. *Note: The signal is still active across the gate. Your pet cannot pass through an open gate.*
- **Gate (Double Loop) (7B):** Bury both Boundary Wires across the gate opening while keeping them three to five feet apart.

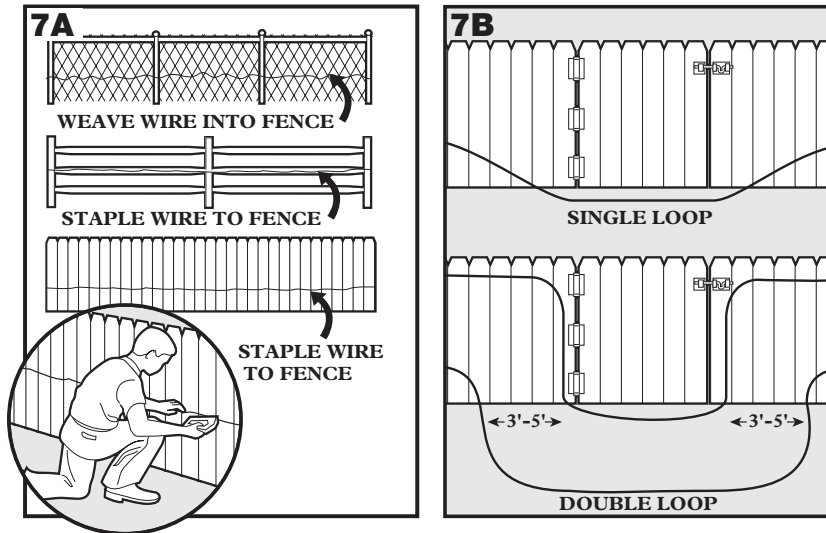

To Cross Hard Surfaces (driveways, sidewalks, etc.)

- **Concrete Driveway or Sidewalk (7D):** Place the Boundary Wire in a convenient expansion joint or create a groove using a circular saw and masonry blade. Place the Boundary Wire in the groove and cover with an appropriate patching compound. For best results, brush away dirt or other debris before patching.
- **Gravel or Dirt Driveway (7E):** Place the Boundary Wire in a PVC pipe or water hose to protect the Boundary Wire before burying.

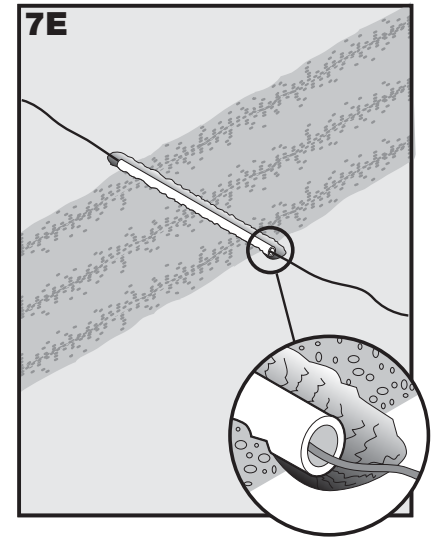
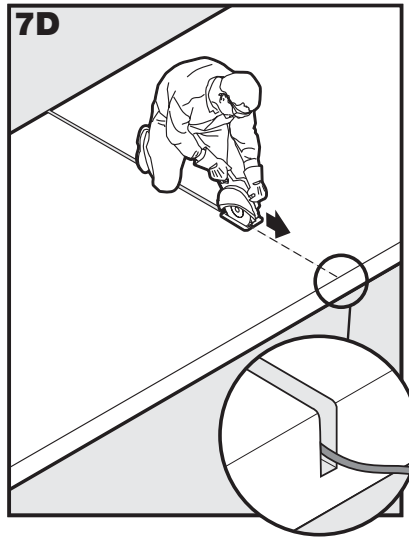

Step 8 Place the Boundary Flags

The Boundary Flags are visual reminders for your pet of where the Warning Zone is located.

1. Hold the Receiver Collar at your pet's neck height.
2. Walk towards the Warning Zone until the Receiver Collar beeps (8A).
3. Place a Boundary Flag in the ground (8B).
4. Walk back into the Pet Area until the beeping stops.
5. Repeat this process around the Warning Zone until it is marked with Boundary Flags every 10 feet.

Note: If you cannot hear the beep, see the Test Light Instructions in Step 6.

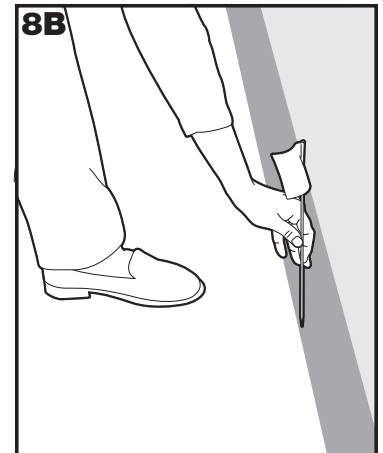

Step 9 Fit the Receiver Collar

Important: The proper fit and placement of your Receiver Collar is important for effective training. The Contact Points must have direct contact with your pet's skin on the underside of his neck.

To assure a proper fit, please follow these steps:

1. Make sure that the battery is not installed in the Receiver Collar.
2. Start with your pet standing comfortably (9A).
3. Center the Contact Points underneath your pet's neck, touching the skin. If your pet has a long or thick coat, use the enclosed long Contact Points to reach through the hair.

Note: It is sometimes necessary to trim the hair around the Contact Points to make sure that contact is consistent.

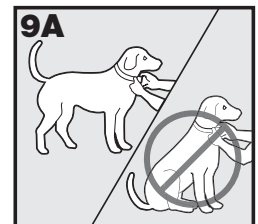

4. Check the tightness of the Receiver Collar by inserting one finger between the end of a Contact Point and your pet's neck. The fit should be snug but not constricting (9B).
5. Allow your pet to wear the collar for several minutes then recheck the fit. Check the fit again as your pet becomes more comfortable with the Receiver Collar.
6. Trim the collar as follows (9C):
 - a. Mark the desired length of the Receiver Collar with a pen. Allow for growth if your pet is young or grows a thick winter coat.
 - b. Remove the Receiver Collar from your pet and cut off the excess.
 - c. Before placing the Receiver Collar back onto your pet, seal the edge of the cut collar by applying a flame along the frayed edge.

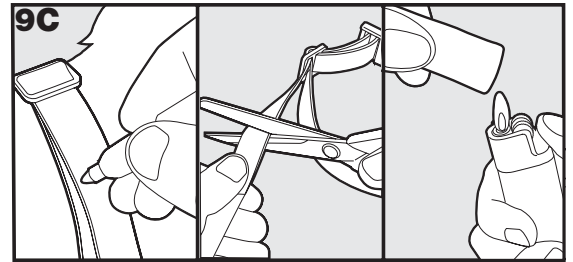

Important: For comfort, safety and effectiveness of product, please ensure the following:

- During the first 2 weeks of training, do not use the training device on your pet without direct supervision.
- Check the fit to prevent excessive pressure by being able to insert one finger between the Contact Point and your pet's skin.
- Your pet must be carefully examined daily for any signs of a rash or sore.
- If a rash or sore is observed, discontinue the use of the Receiver Collar for a few days.
- If the condition persists beyond 48 hours, see your veterinarian.
- Your dog's neck and the Contact Points must be washed weekly with a wash cloth and mild hand soap, then rinsed thoroughly.

A condition called Pressure Necrosis, which is a devitalization of the skin due to excessive and prolonged contact against the Contact Points, may occur if the steps above are not followed.

To Re-Thread the Collar

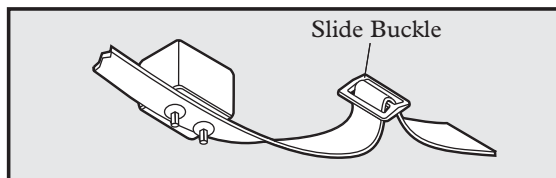

The slide buckle prevents the collar from becoming loose around your pet's neck.

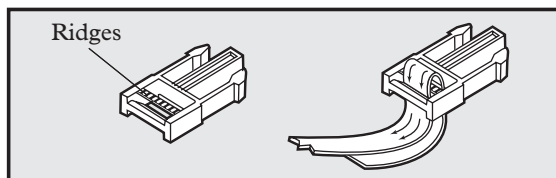

The ridges must be facing up; the collar will slip if it is not properly threaded.

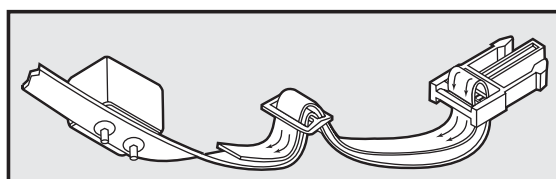

Training Guide

Be Patient With Your Pet

Important: Proper training of your pet is essential to the success of the PetSafe In-Ground Radio Fence™. Read this section completely before beginning to train your pet. Remember that the PetSafe In-Ground Radio Fence™ is not a solid barrier.

- Have fun with your pet throughout the training process. Training should be fun, fair, firm and consistent.
- Train for 10 to 15 minutes at a time. Don't try to do too much too quickly. More-frequent short sessions are better than less-frequent longer sessions.
- If your pet shows signs of stress, slow down the training schedule, add additional days of training, or increase the amount of play time with your pet in the Pet Area. Common stress signals include:
 - Pet pulling on leash toward the house
 - Ears tucked
 - Tail down
 - Body lowered
 - Nervous / frantic movement or stiffening of pet's body
- Your pet must be completely comfortable near the Boundary Flags at the end of every training session. Spend at least 5 minutes of "play time" at the completion of each session within 10 feet of the Boundary Flags.
- Finish each training session on a positive note with lots of praise and play.
- Remove the Receiver Collar after each training session.
- Be sure to contain your pet by another means during the training period (e.g. pen, tie-out, leash, etc.).
- During training, if you need to take your pet out of the Pet Area, remove the Receiver Collar and either pick your pet up or put him in the car to pass out of the Pet Area.
- Even if you think your pet is responding well to the training, complete the entire training. Reinforcement is important!

Phase 1 Days 1 and 2 - Boundary Flag Awareness

Perform three training sessions per day, each lasting 10-15 minutes.

Goal:

To familiarize your pet with the Boundary Flags.

Steps:

1. Begin by walking your pet on a leash in the Pet Area. Your pet will not wear the Receiver Collar for this training step. Calmly praise and talk to your pet.
2. Move toward the Boundary Flags. Just before your pet's head reaches the flag line (10A), give him a quick horizontal or downward "jerk and release" correction on the leash. Do not correct verbally.
3. Lead your pet back into the Pet Area (10B) to about 15 feet away from the Boundary Flags and praise him.
4. Repeat this process at several different Boundary Flags.

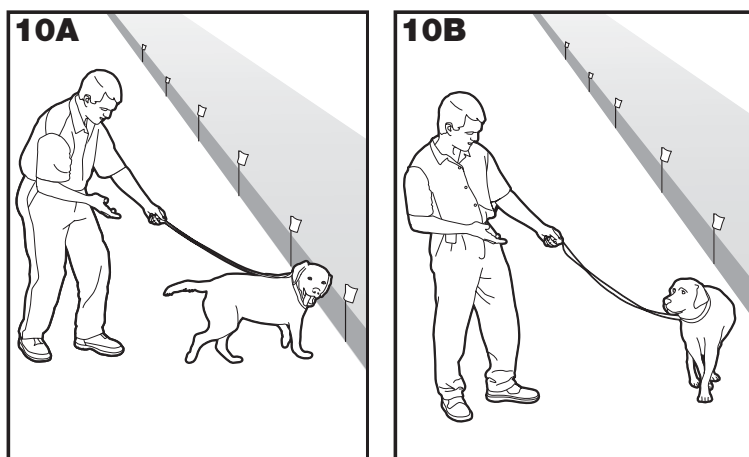

Phase 2 Days 3 and 4 - Continue Boundary Flag Awareness

Perform three training sessions per day, each lasting 10-15 minutes.

Goal:

To introduce your pet to the Static Correction and teach where it happens.

Setup:

- Place the Receiver Collar on your pet's neck.
- Put a separate non-metallic collar on your pet's neck ABOVE the Receiver Collar and attach a leash. *Note: Be sure the extra collar does not put pressure on the Contact Points.*

Steps:

1. Walk your pet on a leash in the Pet Area. Calmly praise and talk to your pet.
2. Allow your pet to move toward the Boundary Flags.
3. When your pet enters the Warning Zone, the Receiver Collar will activate and start beeping. As your pet continues past the flags into the Static Correction Zone (11A), he will receive a Static Correction.
4. Immediately after your pet receives a correction, lead him back into the Pet Area. Praise him warmly and keep very calm body language.
5. Repeat this process at several different Boundary Flags. Never pull or call your pet into the Static Correction Zone. Lead him to the Boundary Flags, and if he decides to not move past the flags, he is learning the system.

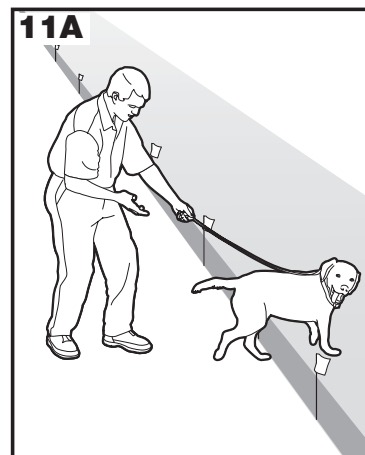

Phase 3 Days 5 thru 8 - Distraction Phase

Perform three training sessions per day, each lasting 10 to 15 minutes.

Goal:

To train your pet to stay within the Pet Area with distractions outside of the Pet Area.

Setup:

- Put a separate non-metallic collar on your pet's neck ABOVE the Receiver Collar and attach a leash. *Note: Be sure the extra collar does not put pressure on the Contact Points.*
- Create distractions to tempt your pet to enter the Warning and Static Correction Zones, such as:
 - Have a family member cross from inside the Pet Area to outside of it.
 - Throw a ball outside of the Pet Area.
 - Have a neighbor walk their pet outside of the Pet Area.

Steps:

1. Walk your pet on a leash toward the Boundary Flags. Have a family member walk outside the boundary. If your pet follows, let him feel a correction and quickly lead him back into the Pet Area and praise him. If your pet does not follow the family member, praise him warmly.
2. Have a family member or a neighbor with a dog walk outside the Pet Area parallel to the Boundary Flag line. Repeat the interaction with your pet as in step 1.
3. With your pet on a leash, throw a ball outside the Boundary Flag line. Again, repeat the interaction with your dog as in previous steps.
4. Repeat distractions at several different Boundary Flags.

Phase 4 Days 9 thru 14 - Unleashed Supervision

4

Training sessions should start at 10-15 minutes, gradually increasing to over an hour.

Your pet is ready for this step only when he clearly avoids the entire Boundary Flag line, regardless of any distractions or temptations. During this step, do not leave your pet unattended.

Goal:

To give your pet free run of the Pet Area off the leash.

Steps:

1. Walk around the yard and play with your pet, staying within the Pet Area at all times.
2. Preoccupy yourself with another task in the yard while watching your pet.
3. Should your pet escape, take the Receiver Collar off or turn the system off at the Fence Transmitter and lead him back into the Pet Area.

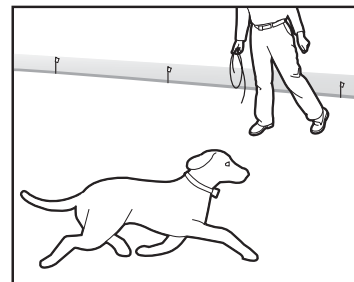

Phase 5 Days 15 thru 30 - Pet Monitoring

5

Your pet is ready to run! Check in on your pet at regular intervals.

Note: After you are satisfied your pet's training is complete, remove every other Boundary Flag every 4 days until all flags are removed. Save Boundary Flags for future use.

Taking Your Pet Out of the Pet Area

Important: Remove the Receiver Collar and leave it in the Pet Area.

Once your pet learns the Boundary Zone, he will be reluctant to cross it for walks or car rides.

Option 1: Replace the Receiver Collar with a regular collar. Put your pet in a car that is within the Pet Area and drive him out of the Pet Area.

Option 2: Replace the Receiver Collar with a regular collar and leash. Walk your pet out of the Pet Area while giving a command such as "OK" at a specific place of the Boundary Zone (the end of your driveway, sidewalk, etc.). Always leave the Pet Area with a leash at this place and your pet will associate leaving the Pet Area only on a leash, only at this place, and only with a person. You may initially need to convince your pet to leave the Pet Area with a food treat and lots of praise.

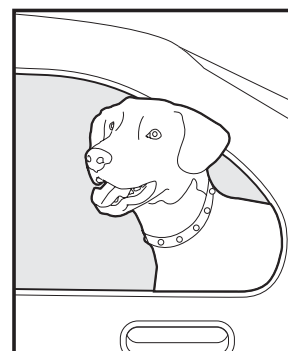

Note: You may also carry your pet out of the Pet Area.

Congratulations! You have now successfully completed the training program.

Accessories

To purchase additional accessories for your PetSafe In-Ground Radio Fence™, contact the Customer Care Center at 1-800-732-2677 or visit our website at www.petsafe.net to locate a retailer near you.

Component	Part Number
Battery - two pack	RFA-67D-11
Power Adapter for the Fence Transmitter	RFA-14
Lightning Protection Kit	RFA-28
Replacement Collar	RFA-41-1
Installation & Training Video (VHS)	RFA-146
Additional Receiver Collar	UL-250BM
Super Pet Receiver Collar	RF-275
Additional Boundary Wire	RFA-1
Additional Boundary Flags	RFA-2
Wire & Flag Accessory Kit	PRFA-500
Fence Transmitter	RF-1010
Wire Break Locator	RFA-50

Troubleshooting

Receiver Collar is not beeping or correcting.	<ul style="list-style-type: none"> • Check battery to make sure it is installed properly. • Check that both lights are lit on the Fence Transmitter. If not, perform the “Short Loop Test”.
The Receiver Collar is beeping, but the pet is not responding to the Static Correction.	<ul style="list-style-type: none"> • Test the Receiver Collar with the Test Light. • If the Test Light flashes, check the fit of the Receiver Collar. • Trim your pet’s fur where the Contact Points touch the neck and/or switch to the longer Contact Points. • Repeat training steps to reinforce training. • Purchase a stronger Receiver Collar by contacting the Customer Care Center at 1-800-732-2677.
The Receiver Collar has to be held on top of the Boundary Wire to activate.	<ul style="list-style-type: none"> • Replace battery. • Adjust Boundary Width Control knob clockwise to increase the distance from the Boundary Wire that the Receiver Collar activates. You can also adjust the Boundary Control Switch to another setting. • If using a Double Loop, make sure Boundary Wires are separated 3 to 5 feet. • If the Receiver Collar still has to be held on top of the Boundary Wire, perform the “Short Loop Test.”
The Receiver Collar activates inside the house.	<ul style="list-style-type: none"> • Turn the Boundary Width Control knob counterclockwise to decrease the distance from the Boundary Wire that the Receiver Collar activates. • Make sure the Boundary Wire is not running too close to the house. The signal can transmit through the walls of your house. • Make sure Boundary Wires are twisted from Boundary to the Fence Transmitter.

<p>I have an inconsistent signal.</p>	<ul style="list-style-type: none"> • Make sure Fence Transmitter is at least 3 feet from large metal objects or appliances. • Make sure all Boundary Wire turns are gradual. • Make sure the Boundary Wire is not running parallel to and within 5 feet of electrical wires, neighboring containment systems, telephone wires, television or antenna cables, or satellite dishes. • If a neighboring containment system may be causing an inconsistent signal, contact the Customer Care Center at 1-800-732-2677 to see if a different frequency system will help your situation.
<p>The Power and Loop Indicator Lights are off.</p>	<ul style="list-style-type: none"> • Check that the Power Adapter is plugged into the Fence Transmitter. • Try plugging into another 120-volt outlet. • If the lights still do not come on, the Fence Transmitter and/or Power Adapter needs to be replaced. Contact the Customer Care Center at 1-800-732-2677.
<p>The Power Light is on, the Loop Indicator Light is off, and the Fence Transmitter loop alarm is sounding.</p>	<ul style="list-style-type: none"> • Make sure both ends of the Boundary Wire are plugged into Boundary Wire Terminals and that ½ inch of the insulation is stripped so that the copper wire is exposed. • Perform the “Short Loop Test” to determine if the Fence Transmitter needs to be replaced or if the Boundary Wire is broken. • If the Fence Transmitter is functioning properly, you have a break in your Boundary Wire. See the “Locating a Break in the Wire” section in this guide.

Additional Information

- The Boundary Wire is buried so that it is not accidentally tripped over or cut. Use care when using a weed eater or when digging near the Boundary Wire to prevent damage.
- The system should only be used with healthy pets. Contact your veterinarian if you have concerns about the medical condition of your pet (medication, pregnant, heart conditions, etc.).
- This system is not for vicious or aggressive pets. If your pet may pose a threat to others, **DO NOT USE THIS SYSTEM.** If you are unsure if your dog is aggressive, please consult your veterinarian or a certified trainer.
- The PetSafe In-Ground Radio Fence™ is for residential use only.
- The Static Correction will get your pet’s attention, but will not cause harm. It is designed to startle, not to punish.
- Test the Receiver Collar every 3 to 6 months. Battery life depends upon how often the Receiver Collar is activated.

Short Loop Test

The Short Loop Test is a simple test to determine if each component (Fence Transmitter, Receiver Collar and Boundary Wire) is functioning properly.

1. Disconnect the Boundary Wire.
2. Cut approximately 10 feet of unused Boundary Wire and connect it to the Boundary Wire Terminals.
3. Attach the Test Light to the Receiver Collar.
4. Spread the Boundary Wire out into a circle. Set the Boundary Control Switch to **B**.
5. Set the Boundary Width Control knob to 10.
6. If the Loop Indicator Light is not lit, then your Fence Transmitter is not functioning properly. Contact the Customer Care Center at 1-800-732-2677.
7. If the Loop Indicator Light is lit, disconnect one end of the Boundary Wire from the Boundary Wire Terminal.
8. If the loop alarm does not sound, the Fence Transmitter needs to be replaced. Contact the Customer Care Center at 1-800-732-2677.
9. If the loop alarm does sound, plug the Boundary Wire back into the Boundary Wire Terminal.
10. Hold the Receiver Collar next to the 10-foot length of Boundary Wire. The Receiver Collar should beep about one foot away from the Boundary Wire. The Test Light should then flash as you hold the Receiver Collar closer to the Boundary Wire.
11. If Receiver Collar does not beep and the Test Light does not flash, replace the battery in the Receiver Collar. If it still does not beep and the Test Light does not flash, contact the Customer Care Center at 1-800-732-2677.
12. If the Receiver Collar beeps, there may be a complete or partial break in the Boundary Wire. See the “To Locate a Break in the Boundary Wire” section.

To Locate a Break in the Boundary Wire

Please follow these steps in determining where you have a break in your Boundary Wire:

1. Locate your original splice(s) and verify they have a good, solid connection.
2. Check your yard to determine any possible damage to the Boundary Wire (e.g. recent digging, aerating, rodent burrowing, or any other noticeable disturbance in your yard next to the Boundary Wire).

If you still cannot find the break in the Boundary Wire, there are two options for locating it:

Option 1: Contact the Customer Care Center at 1-800-732-2677 to purchase a Wire Break Locator that will locate the break in the Boundary Wire.

Option 2: Follow the procedure below:

1. Unplug the Fence Transmitter.
2. Connect both ends of your twisted Boundary Wire to one Boundary Wire Terminal.
3. Measure and cut a Test Wire which is half the length of your total Boundary Wire footage.
4. Connect one end of Test Wire to the other Boundary Wire Terminal.
5. Locate the halfway point of your boundary and cut the Boundary Wire.
6. Splice the other end of the Test Wire to either side of your Boundary Wire where you cut it in half.
7. Plug in the Fence Transmitter and check the Loop Indicator Light. If the Loop Indicator Light is on, you can assume the break is in the other half of the Boundary Wire.
8. If the Loop Indicator Light did not come on, you may assume there is a break in this portion of the Boundary Wire. However, there is a small chance of having more than one break in your system. Be sure to check both halves of your entire loop.
9. Replace the damaged Boundary Wire with new Boundary Wire.
10. Reconnect the Boundary Wire to the Fence Transmitter.
11. Check the Loop Indicator Light. If the Loop Indicator Light is on, test the system with the Receiver Collar.

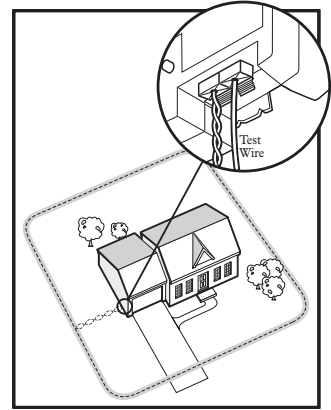

Terms of Use and Limitation of Liability

1. Terms of Use

This Product is offered to you conditioned upon your acceptance without modification of the terms, conditions and notices contained herein. Usage of this Product implies acceptance of all such terms, conditions, and notices.

2. Proper Use

This Product is designed for use with pets where training is desired. The specific temperament of your pet may not work with this Product. We recommend that you not use this Product if your pet is less than 8 pounds or if your pet is aggressive. If you are unsure whether this is appropriate for your pet, please consult your veterinarian or certified trainer.

Proper use includes reviewing the entire Guide provided with your Product and any specific Caution statements.

3. No Unlawful or Prohibited Use

This Product is designed for use with pets only. This pet training device is not intended to harm, injure or provoke. Using this Product in a way that is not intended could result in violation of Federal, State or local laws.

4. Limitation of Liability

In no event shall Radio Systems Corporation be liable for any direct, indirect, punitive, incidental, special or consequential damages, or any damages whatsoever arising out of or connected with the use or misuse of this Product. Buyer assumes all risks and liability from the use of this Product.

5. Modification of Terms and Conditions

Radio Systems Corporation reserves the right to change the terms, conditions and notices under which this Product is offered.

FCC

This equipment has been tested and found to comply with the limits for a Class B digital device, pursuant to Part 15 of the FCC Rules. These limits are designed to provide reasonable protection against harmful interference when the equipment is operated in a residential environment. This equipment generates, uses, and can radiate radio frequency energy and, if not installed and used in accordance with the instruction guide, may cause harmful interference to radio communications. However, there is no guarantee that interference will not occur in a practical installation. If this equipment causes harmful interference to radio or television reception, which can be determined by turning the equipment off and on, the user is encouraged to try to correct the interference by one or more of the following measures:

- Relocate the interfered receiving antenna.
- Increase the separation between the equipment and receiver.
- Connect the equipment into an outlet on a circuit different to that to which the receiver is connected.
- Contact the Customer Care Center at 1-800-732-2677.

Unauthorized changes or modifications to the equipment, not approved by Radio Systems Corporation, could result in not meeting compliance with FCC regulations and could void the user's authority to operate the equipment.

Caution

The PetSafe In-Ground Radio Fence™ is NOT a solid barrier. The system is designed to act as a deterrent to remind pets by electric stimulation to remain in the boundary established. It is important that you reinforce training with your pet on a regular basis. Since the tolerance level to electrical stimulation varies from pet to pet, Radio Systems Corporation CANNOT guarantee that the system will, in all cases, keep a pet within the established boundary. Not all pets can be trained to avoid crossing the boundary! Therefore, if you have reason to believe that your pet may pose a danger to others or harm himself if he is not kept from crossing the boundaries, you should NOT rely solely upon the PetSafe In-Ground Radio Fence™ to confine your pet. Radio Systems Corporation shall NOT be liable for any property damage, economic loss or any consequential damages, sustained as a result of any animal crossing the boundary.

Layout Grid

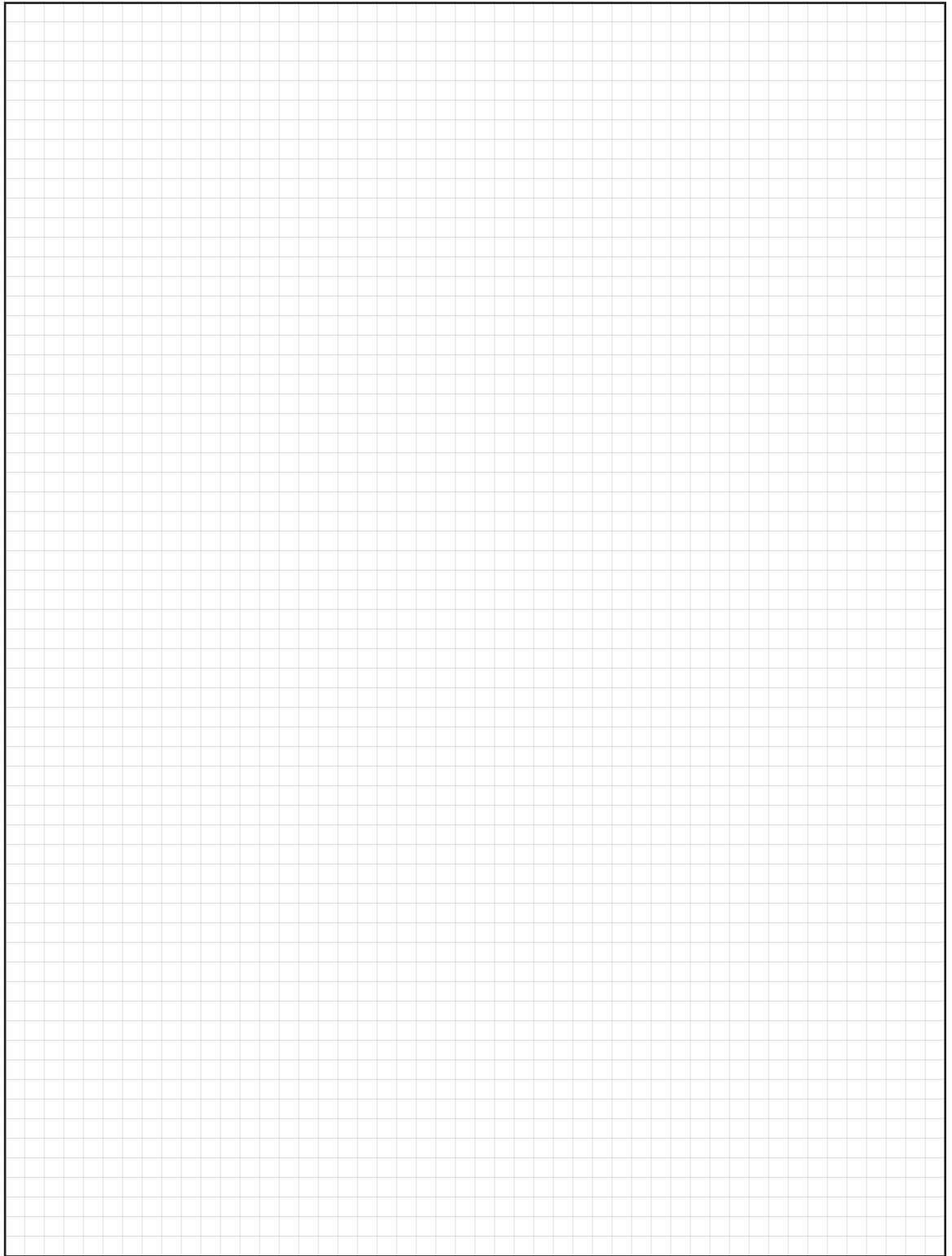

Mounting Template

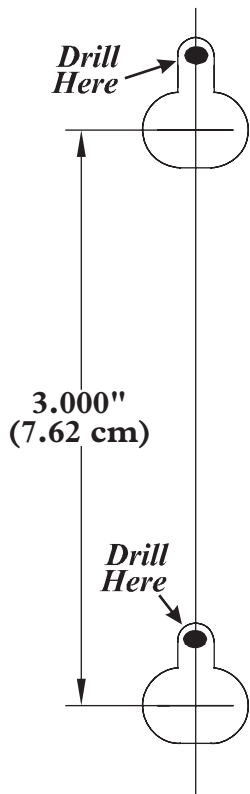

Radio Systems Corporation
10427 Electric Avenue
Knoxville, TN 37932
1-800-732-2677
www.petsafe.net
400-662